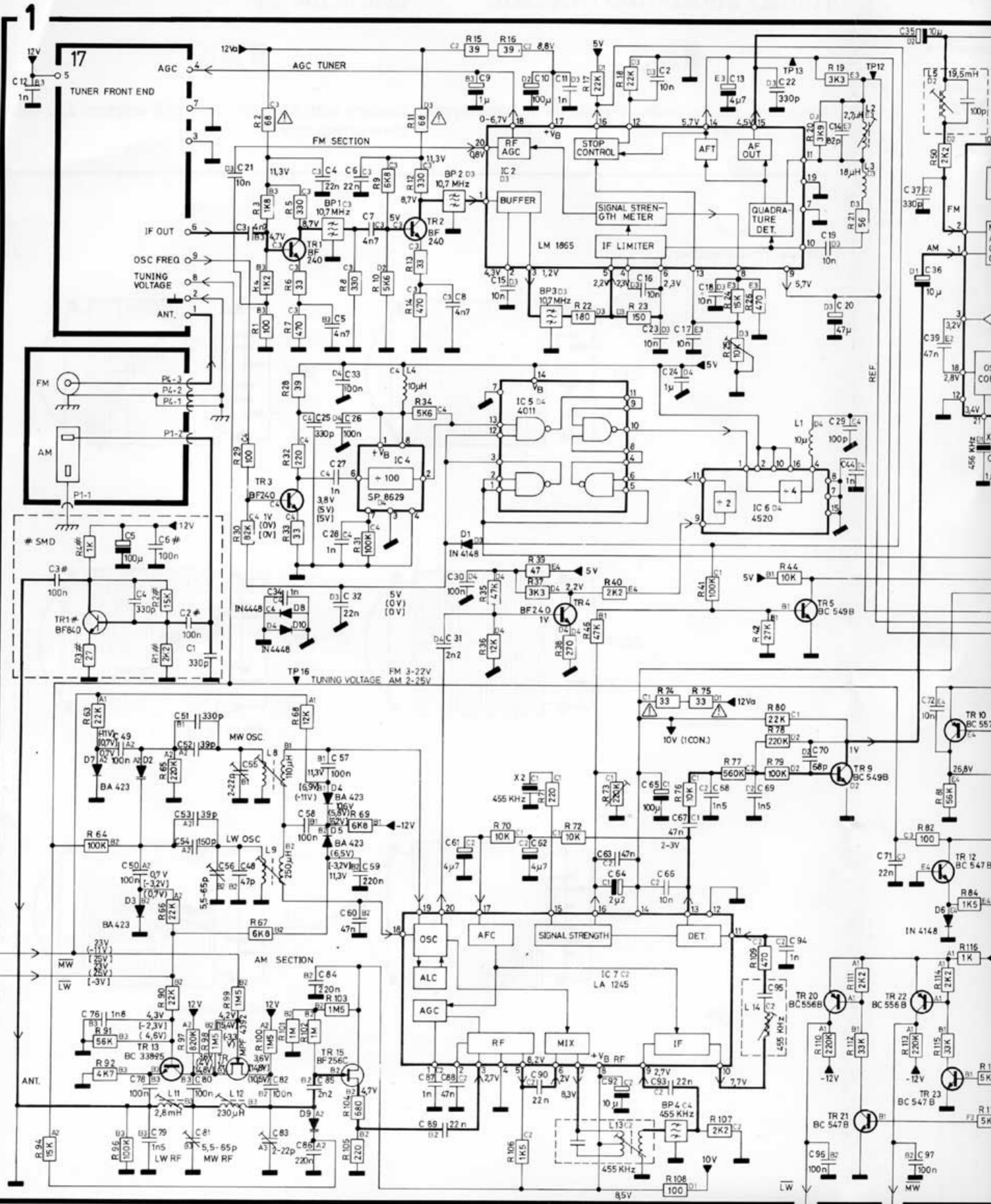
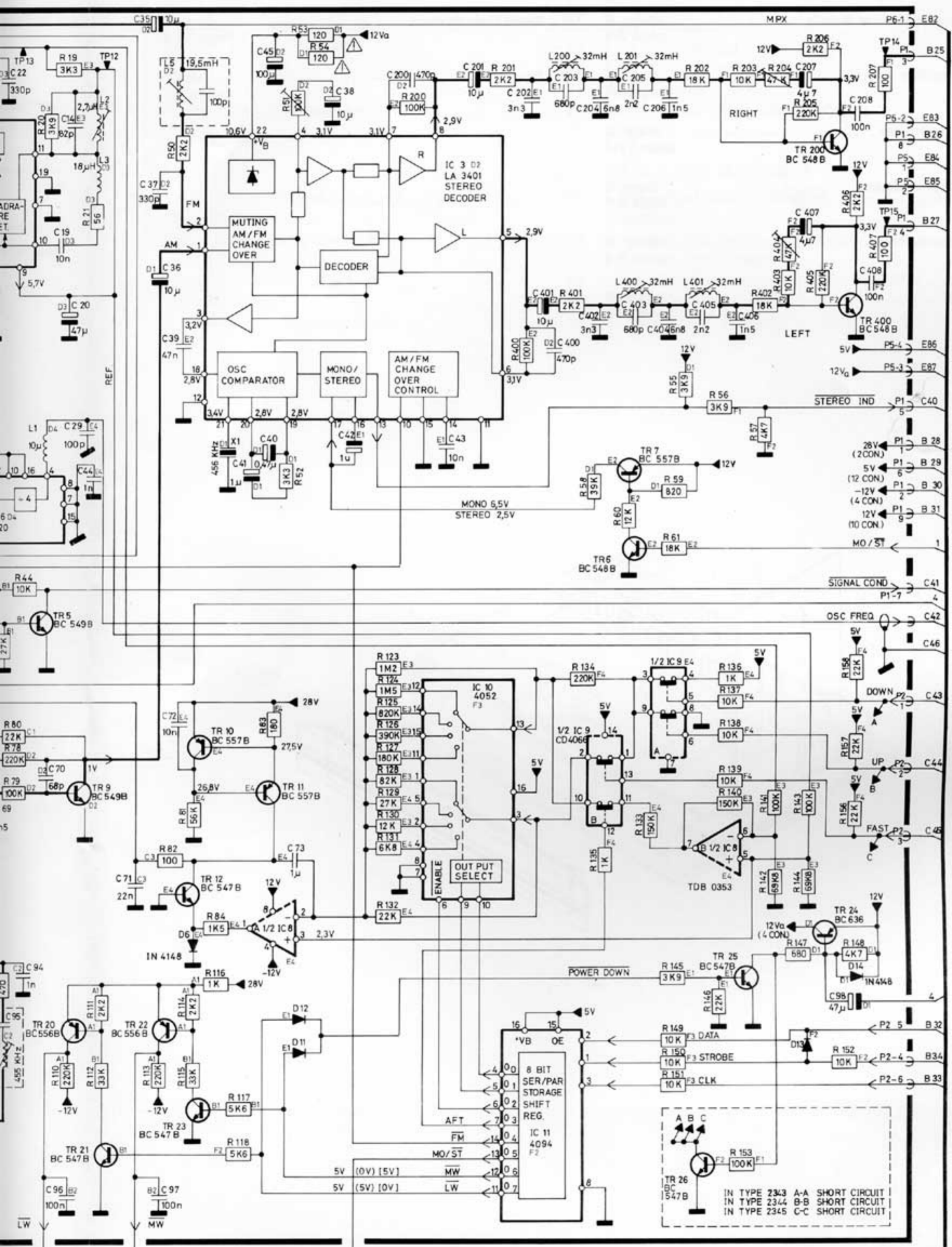

DIAGRAM A AM-FM, TUNER, IF, STEREO DECODER (Type 2341, 2342)





IN TYPE 2343 A-A SHORT CIRCUIT
 IN TYPE 2344 B-B SHORT CIRCUIT
 IN TYPE 2345 C-C SHORT CIRCUIT

DIAGRAM A AM-FM, TUNER, IF, STEREO DECODER (Type 2343, 2344, 2345)

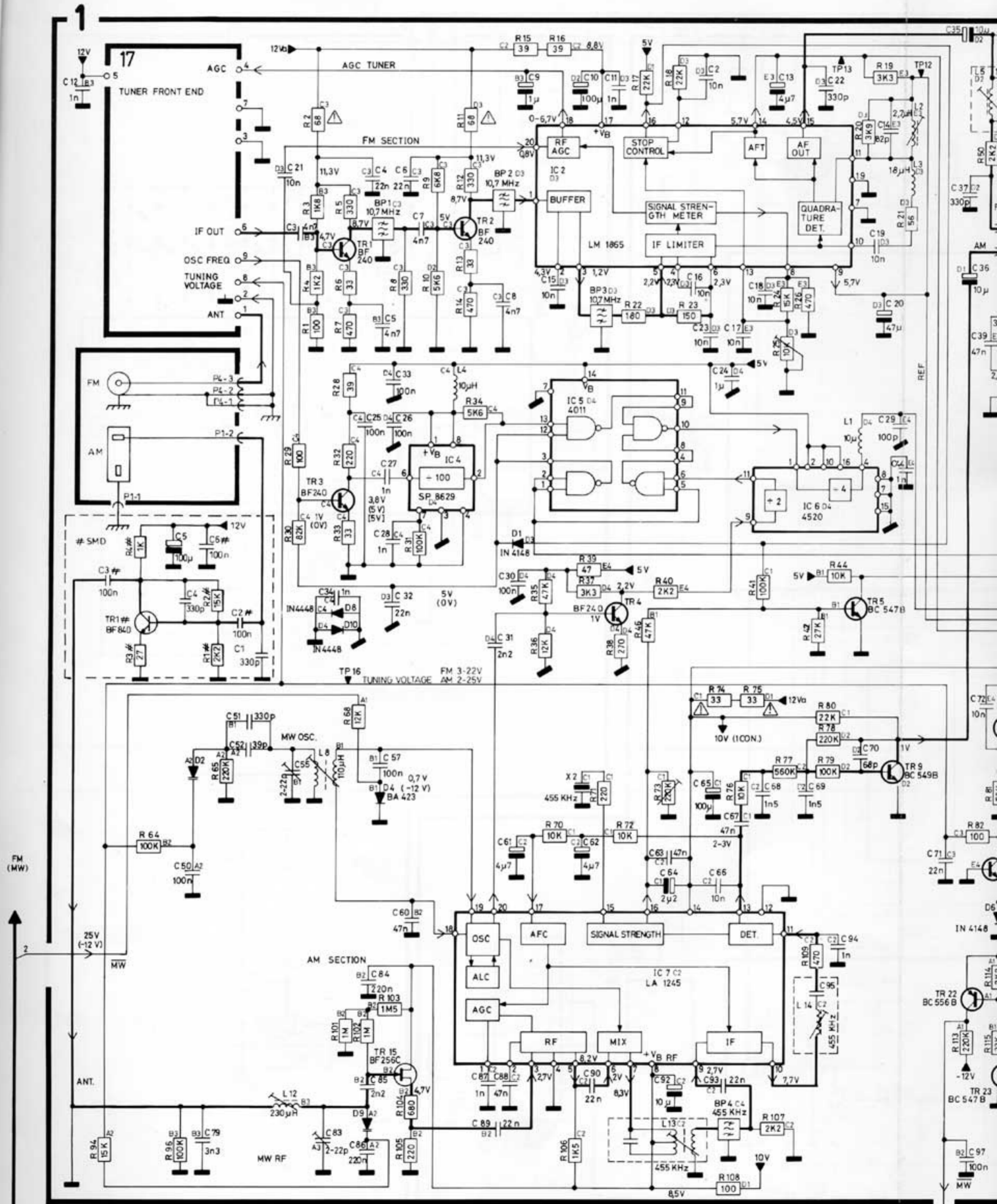

(X CON) = NUMBER OF VOLTAGE CONNECTIONS

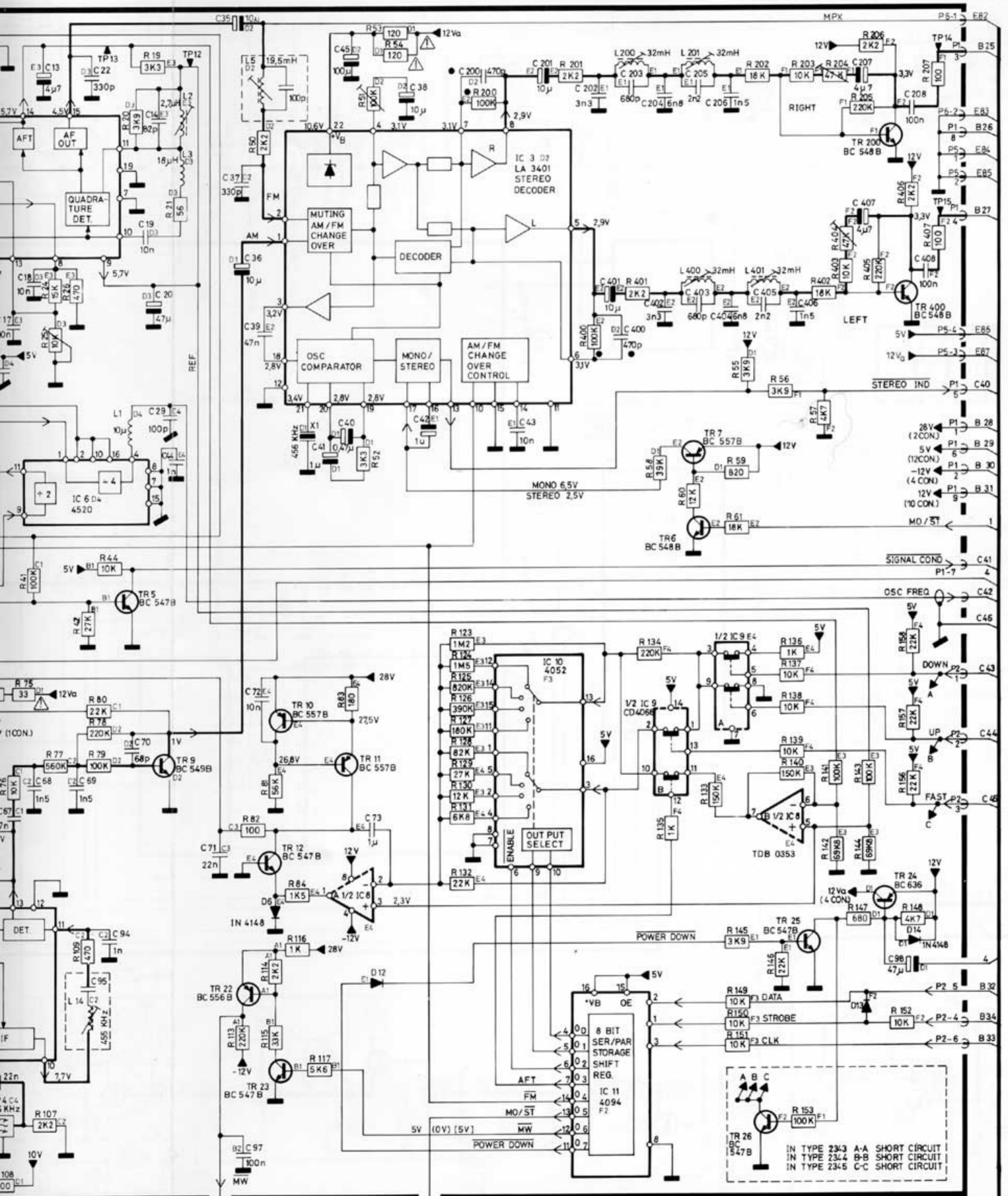
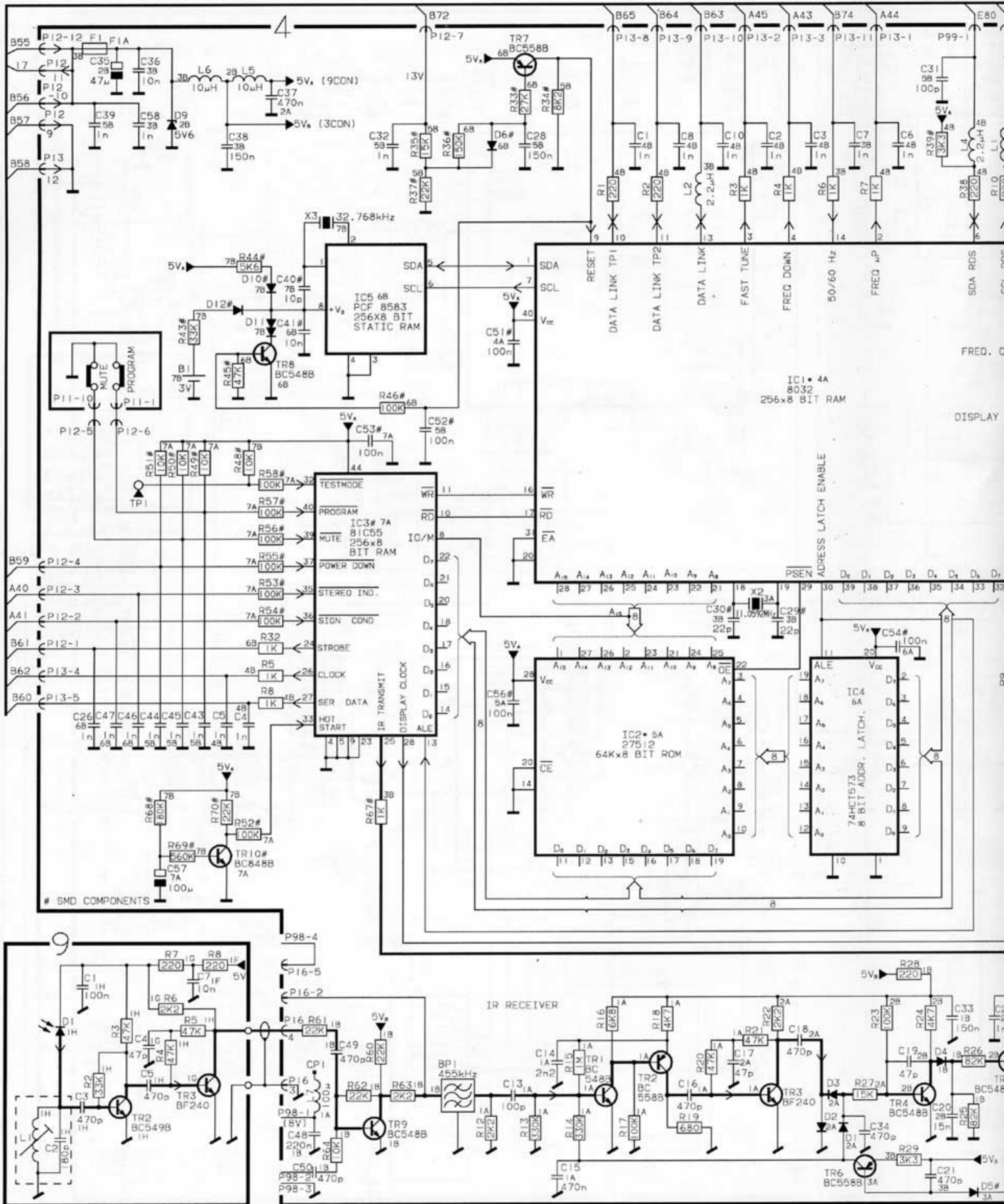
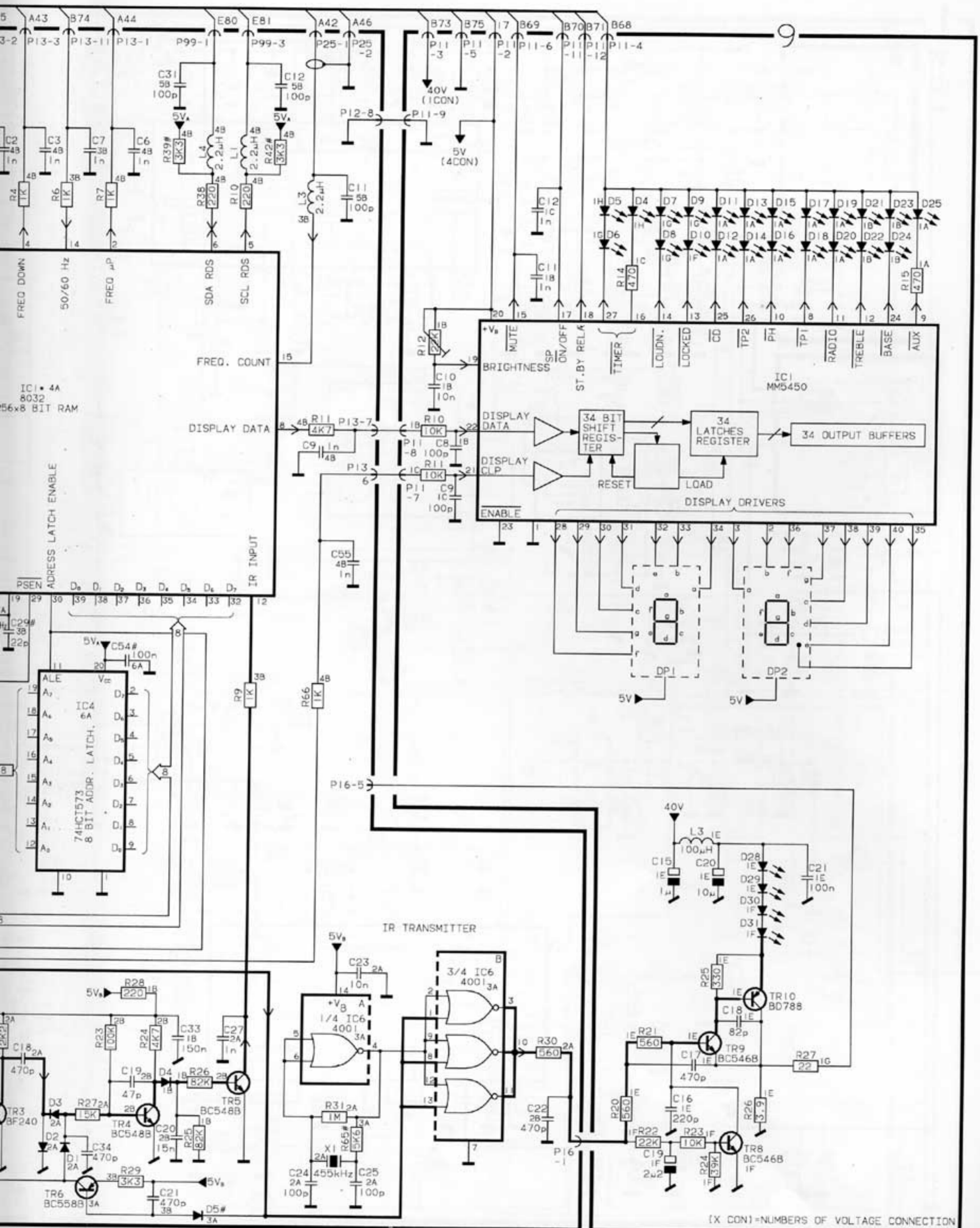

DIAGRAM C MICROCOMPUTER, IR TRANSCEIVER, DISPLAY





Corrections for Beomaster 6500

DIAGRAMS

Page 2-4:

2R18 must be 5020881 22Ω 5% 1/4W

An kondensator part no. 4200510 10μ 20% 16V has been added to the collector on 2TR16.

3R81 and 3R84 5010092 220Ω 5% 1/4W has been added:

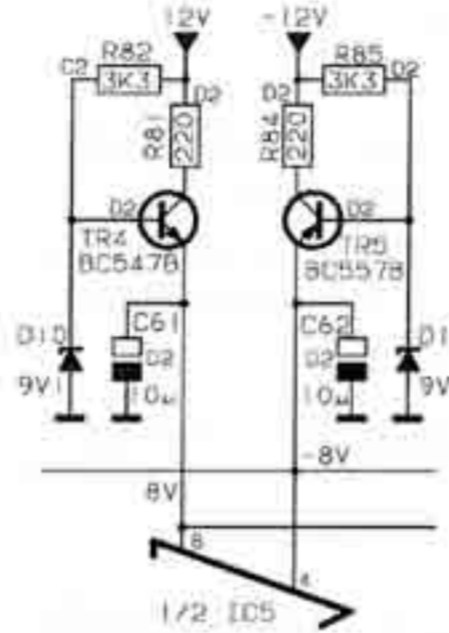

7TR2 BC338 is an NPN transistor. Emitter to the ground.

Page 2-5:

Connection to pin 7 (TEST) on 4IC2 is deleted.

The value of 4X1 is 11.0592MHz

Part no. on 4IC1* must be 8341069

Part no. on 4IC4* must be 8341309

Part no. on PCB 9 must be 8001284

List of Electrical Parts
page 3-3

2C6, 2C7 must be 4200530 10000μF 20% 50V

2RL6 is named wrong. 2RL1 is correct

List of Mechanical Parts
page 4-3

12 Modul part no. must be 8002821

9504	2804055 Wheel
9510	2854128 Arm
9511	2576050 Spacer

Accessories
page 4-4

8087016 IR-sensor kit

DIAGRAM E RADIO DATA SYSTEM

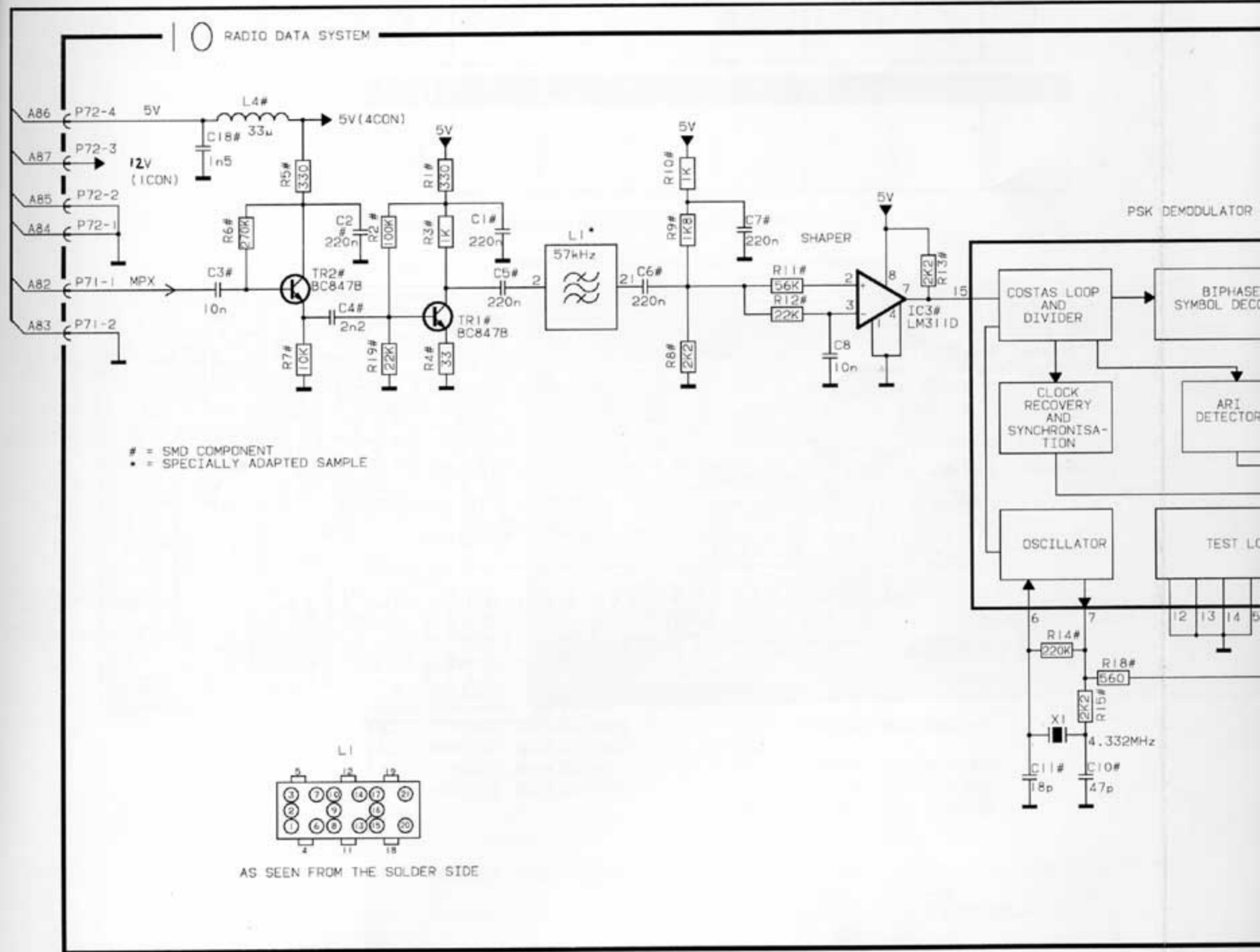

SMD Survey

- : rear side
- : rear side

PCB 1, Amp. f. AM loop antenna

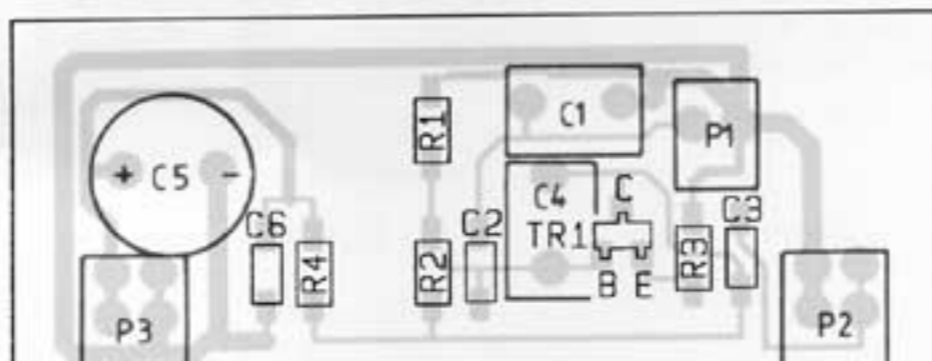

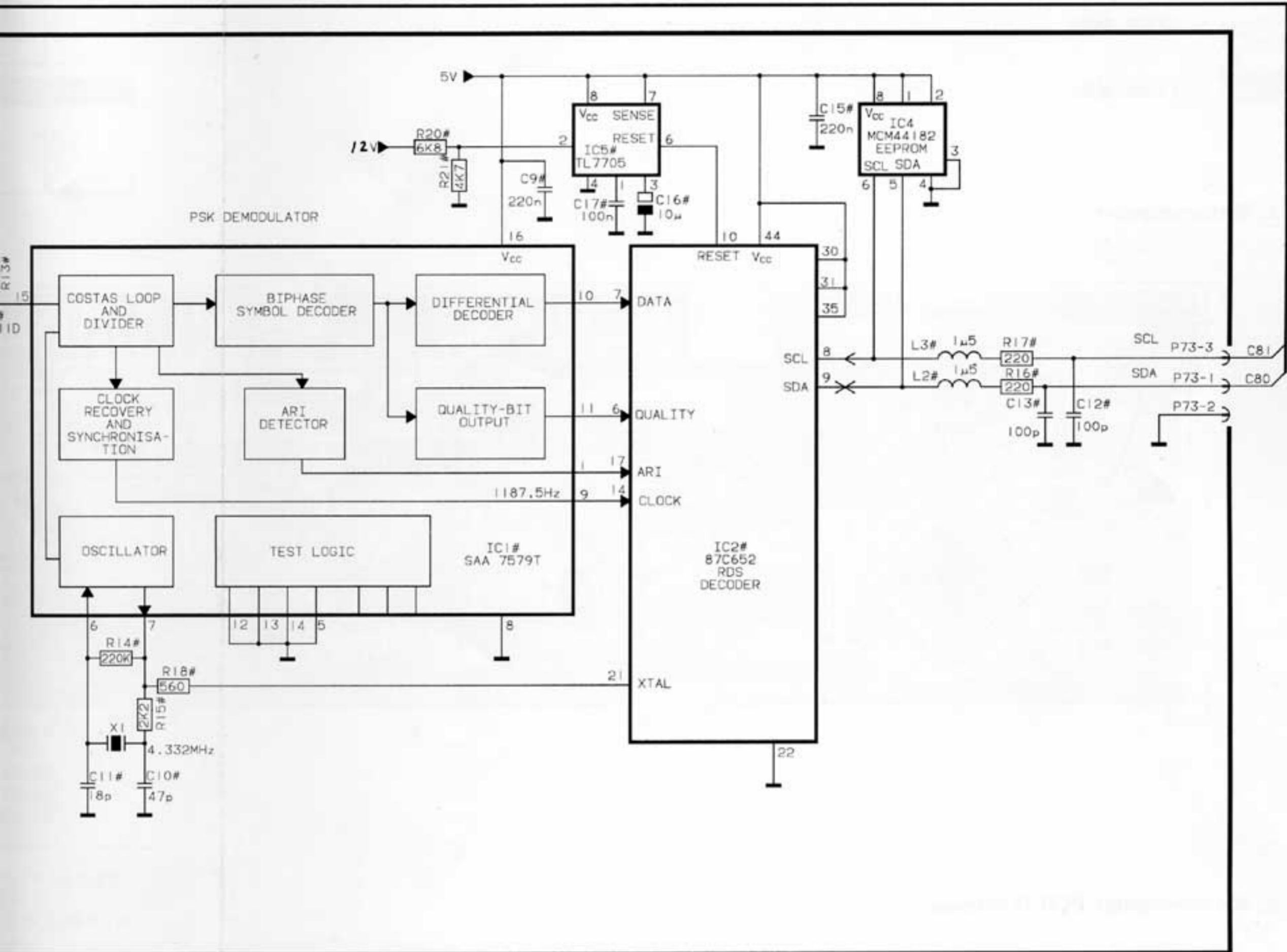

PCB 10, RDS

